

















## SILLA DELANTERA PREMIUM



- |   |   |   |   |   |   |
|---|---|---|---|---|---|
| 1  x2    | 2  x4  | 3  x8  | 4  x1  | 5  x1   | 6  x2  |
| 7  x4   | 8  x1  | 9  x1  | 10  x1 | 11  x2 | 12  x2 |
| 13  x1 | 14  x1 | 15  x1 | 16  x4 |   |   |

COMPONENTES

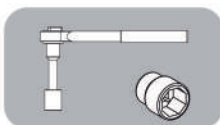
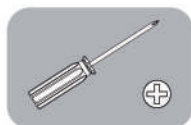

HERRAMIENTAS

# COLOCACIÓN DE PROTECTORES PIE

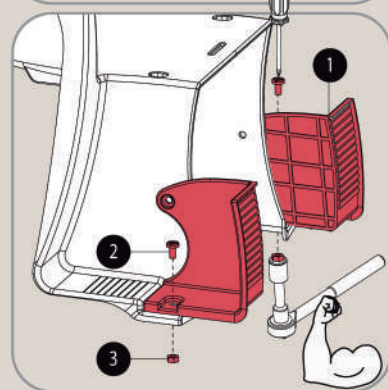
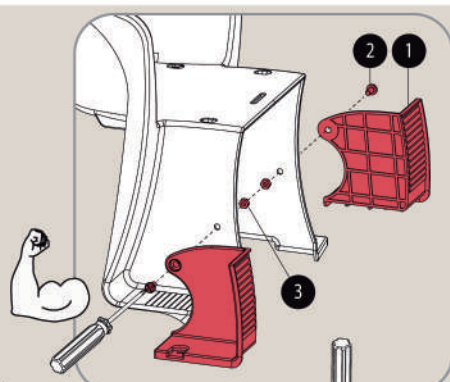
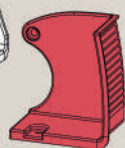
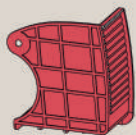
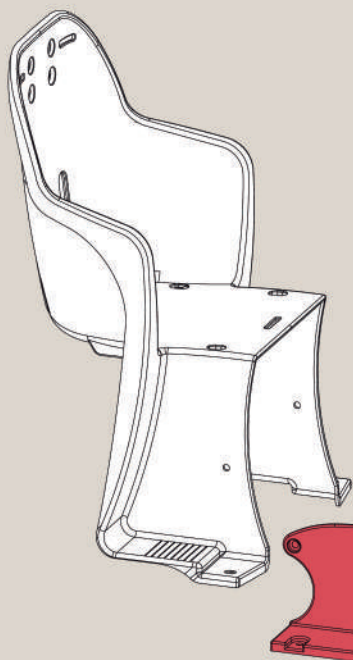

# ARMADO DE CINTURON

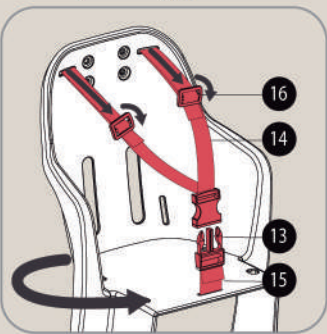
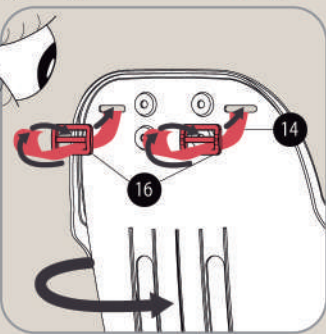
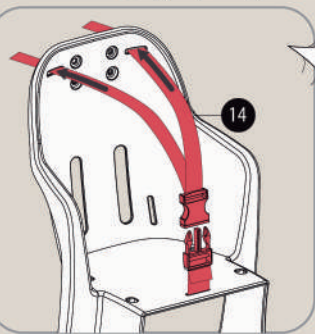
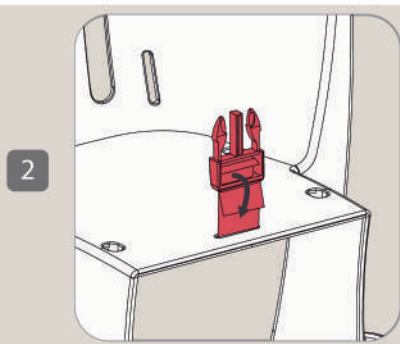
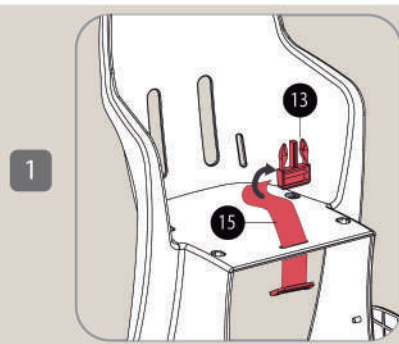

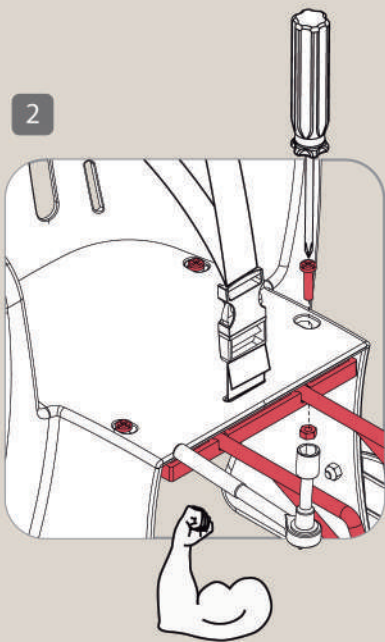
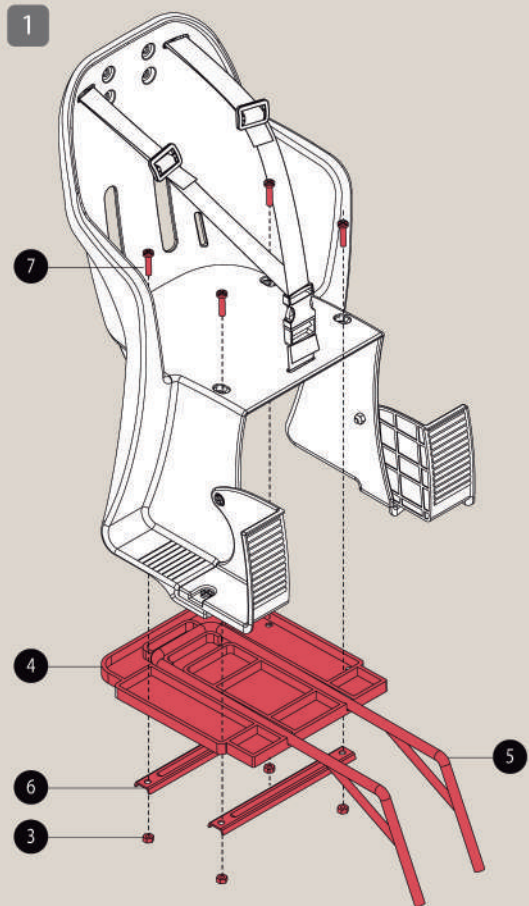
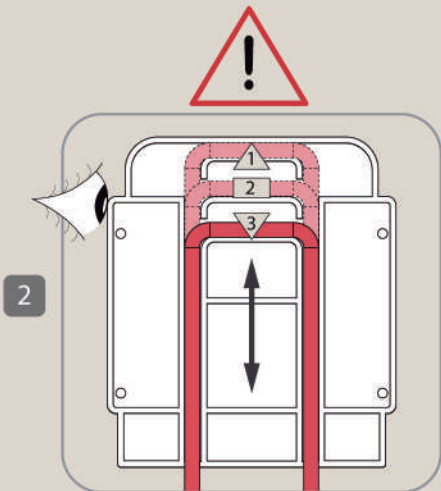
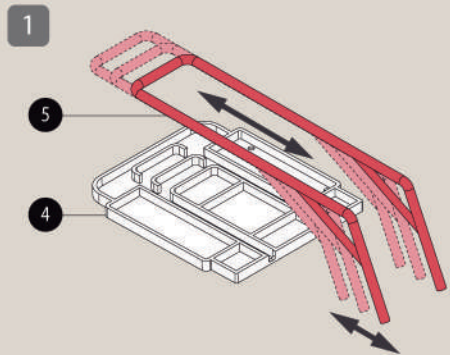

1

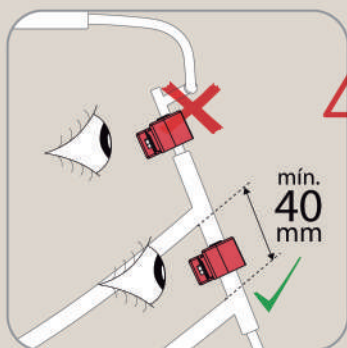

8

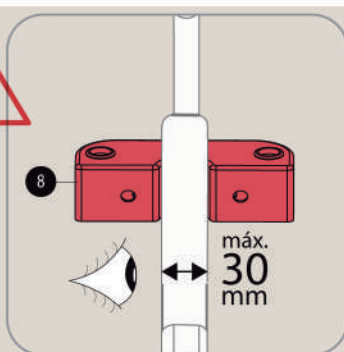

2

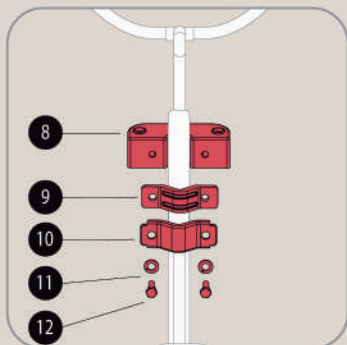

3

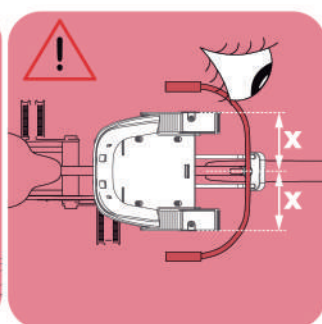
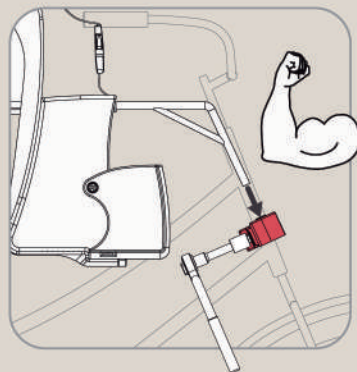

**PLÁSTICA VC S.R.L.** no se hará responsable por una defectuosa instalación del producto, ni el daño causado por accidentes, negligencia y mal uso en general o deterioro de la sillita debido al uso normal

+ información en

